



uPVC Door and Window Systems  
Product Catalogue





**uPVC Door and Window Systems  
Product Catalogue**



**A better world is possible tomorrow  
We are working to be..**

We believe sustainability is more than reducing our carbon footprint. Acting with the belief that it is; environmental, social and economic perspectives should be considered as a whole. With this perspective, we continue our activities in all our business areas. We operate within the framework of a business approach in all our business areas with this perspective, respectful to the environment, serving the future of our country and our world.

As ASAŞ, we continue to make all investment and production decisions on the axis of our sustainability oriented strategy in order to make a better world possible tomorrow.



## ASAŞ

With a steady growth trend since its establishment in 1990, ASAŞ is one of the leading manufacturers in Europe, exporting to more than 90 countries in 6 continents. The company serves its customers in the field of Aluminium Profile, Aluminium Composite Panel, Aluminium Flat Products, uPVC Profile and Shutter Production Facilities, established on 400.000 m<sup>2</sup> closed complex in a total area of 1.000.000 m<sup>2</sup> factory in Turkey. ASAŞ, while offers solution partnerships to many sectors such as;

- Construction
- Automotive
- Rail Systems
- Commercial Vehicles
- Aerospace Industry
- Energy
- Packaging
- Consumer Products
- Maritime Industries

The company aimed to provide fast and solution-oriented service especially to the European market with ASAŞ GmbH, which was established in 2018 in Koblenz, adjacent to Neuwied region in Germany. With the establishment of subsidiary, which is positioned as a logistics and service center in an area of 880.000 m<sup>2</sup>, of which 72,793 m<sup>2</sup> is closed, the European activities of the company continue with a rapid growth.

Video



## WHY uPVC?



### Good Mechanical Strength

The abrasion resistance, lightness and good mechanical strength and toughness of uPVC profiles used in the production of windows and doors provide very important technical advantages in its use in building and construction applications.



### Fire Resistance

uPVC is naturally difficult to ignite, its ignition temperature is high. Combustion stops immediately when the heat source is removed. This feature makes uPVC suitable for windows, doors, coatings, etc. makes it particularly suitable for applications.



### Durability

uPVC is resistant to weathering, chemical rot, corrosion, shock and abrasion. For this reason, it is preferred by customers in products exposed to open air and in places where many different longevity is desired.



### LCA

The environmental impact of uPVC has been found to be positive when compared to other materials used in the production of window profiles and doors according to LCA (Life Cycle Assessment) analysis.



### Sustainable

Construction materials such as pipes, window profiles and flooring can be reused at the end of their life. With this feature, uPVC provides significant benefits in terms of environment and economy.



### Energy Efficient

In buildings, 28 percent of the energy escapes through the windows. The heat transmission coefficient of uPVC material is better and a strong insulation material against sound, humidity and similar external effects.



## Content

- 8• Inova 76 mm Middle Gasket
- 10• Inova 76 mm
- 12• Inova New Generation Sliding Systems
- 14• Hebe Schiebe
- 16• Maxi Royal 70 mm
- 18• Elegans 70 mm
- 20• Maxi Riviera
- 22• Maxi Majestic
- 24• Maxi Empire
- 26• Elegans 60 mm
- 28• Diamond 60 mm
- 30• Sliding System 74 mm
- 32• Sliding System 70 mm
- 34• Compact Sliding System 60 mm
- 36• Sill Profiles
- 39• Colour Options
- 40• External Roller Shutter Systems
- 42• uPVC and Aluminium Monoblock Roller Shutter Systems
- 44• Tubular Motors and Control Systems
- 46• Zebra Roller Shutter
- 48• Daylight
- 50• The Quality Policy



## INOVA 76 mm MIDDLE GASKET

Inova 76 mm Middle Gasket System aims to provide maximum heat and sound insulation having 7 chambers, 3 gaskets (with middle gasket) and special glass that has 50 mm width. The system has 76 mm profile width. By applying heat-insulated aluminium threshold profile, it enables threshold application at a lower height.

Properties		Type of Openings
Profile Width (mm)	76	
Number of Chamber for Frame Profile	5, 6, 7	
Glass Thickness (mm)	24 - 50	
Thermal Insulation ( $U_w$ ) W/m <sup>2</sup> K	0,78	
Air Permeability	Class 4	
Wind Load Resistance	Class C5/B5	

Technical Sheet  
 Sash 3D  
 Dropper Sash 3D







Sustainable    Lead Free









## INOVA 76 mm

Inova 76 mm System aims to provide maximum heat and sound insulation with multiple chambers and special glass that has 50 mm width. The system has 76 mm profile width.

Properties	Type of Openings
 Profile Width (mm) 76	
 Number of Chamber for Frame Profile 5,6	
 Glass Thickness (mm) 24 - 50	

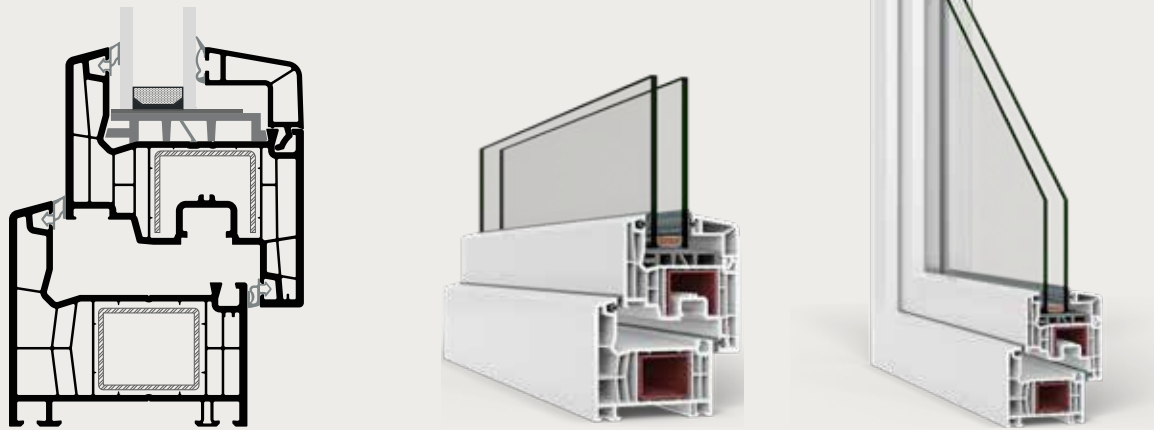
Technical Sheet  3D 



 Sustainable  Lead Free





## INOVA NEW GENERATION SLIDING SYSTEM

Inova, which gives life to large spaces with its double-sash application alternative, guarantees that it is the system with the best insulation value among the existing sliding systems, with the performance tests carried out in the Ift Rosenheim Germany-approved test laboratory. With a maximum accessory weight of 400 kg and a glass weight of 80 kg/m<sup>2</sup>, Inova, which can be applied up to 3000 mm width and 3600 mm height, also puts an end to security concerns thanks to the locking and pressure points surrounding the wing profile.

Properties		Type of Openings												
Profile Width (mm)	147	<table border="1"> <tr> <td>x</td><td>┌</td><td>x</td><td>┌</td><td>┌</td><td>x</td> </tr> <tr> <td>x</td><td>└</td><td>x</td><td>└</td><td>└</td><td>x</td> </tr> </table>	x	┌	x	┌	┌	x	x	└	x	└	└	x
x	┌		x	┌	┌	x								
x	└	x	└	└	x									
Glass Thickness (mm)	24 - 50													
Thermal Insulation (U <sub>w</sub> ) W/m <sup>2</sup> K	1,40	<table border="1"> <tr> <td>x</td><td>└</td><td>x</td><td>x</td><td>x</td> </tr> <tr> <td></td><td>└</td><td></td><td>└</td><td>x</td> </tr> </table>	x	└	x	x	x		└		└	x		
x	└		x	x	x									
	└		└	x										
Air Permeability	Class 4													
Wind Load Resistance	Class B3													
Inova New Generation Sliding System (mm)	1500x3000 2000x3600	<div style="display: flex; justify-content: space-around; align-items: center;"> <div style="text-align: center;"> <p>Video</p> </div> <div style="text-align: center;"> <p>Technical Sheet</p> </div> <div style="text-align: center;"> <p>3D</p> </div> </div>												
Maximum Sash Weight (kg)	400													

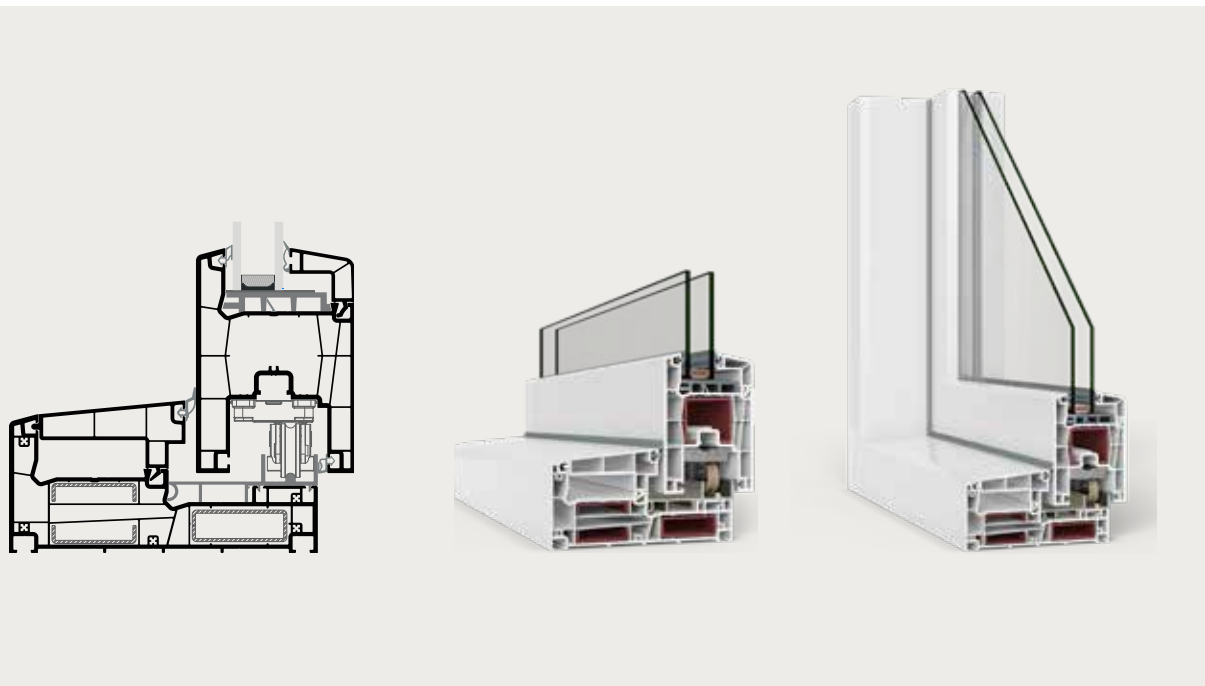





Sustainable Lead Free



## HEBE SCHIEBE

Case Depth has a width of 170 mm. Door sash profile has a width of 70 mm. The wall thickness of the case and sash profile is A class. Heat insulation of the aluminium sill profile is ensured with uPVC sill closure from the inside.

Properties	Type of Openings
 Profile Width (mm)	170
 Glass Thickness (mm)	4 - 40
 Air Permeability	Class 3
 Wind Load Resistance	Class C4/B5

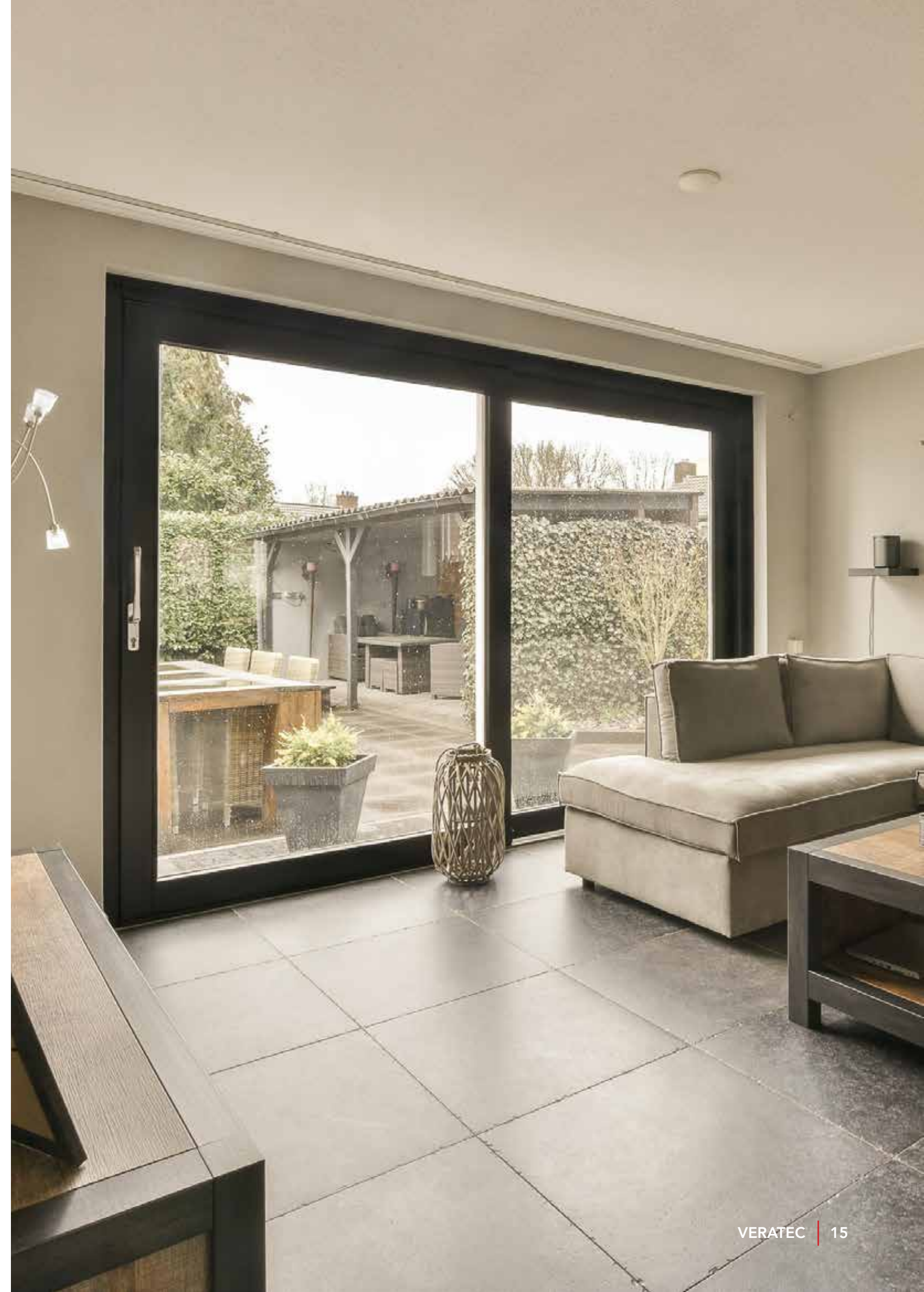
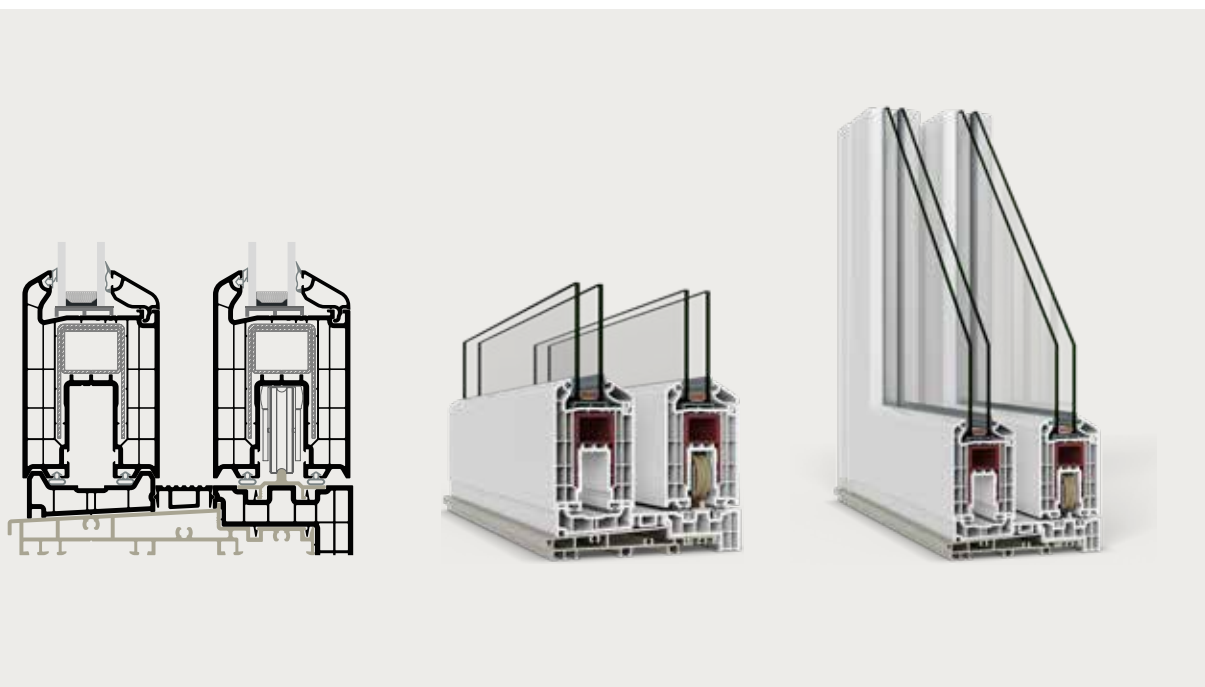
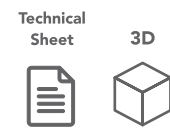
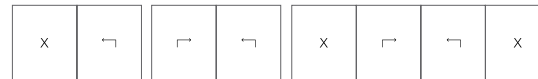



## MAXI ROYAL 70 mm

The system has a 70 mm profile depth. Aluminium cover application is possible for an aesthetic appearance on the outer surface. Aluminium covers are designed especially to provide outstanding insulation with PVC profiles. The system also has an outward opening sash profile.

Properties		Type of Openings
Profile Width (mm)	70	
Number of Chamber for Frame Profile	5 - 6	
Glass Thickness (mm)	4 - 40	
Thermal Insulation ( $U_w$ ) W/m <sup>2</sup> K	1,45	
Air Permeability	Class 4	
Wind Load Resistance	Class C5/B5	

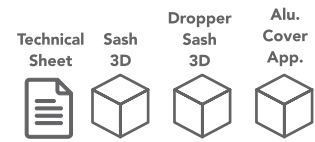

Sustainable Lead Free





## ELEGANS 70 mm

To ensure maximum sound and heat insulation with its 5-chambered design, it provides usage opportunity for quality glasses with a thickness of 4, 20, 24, 28, 34 and 40 mm and different lath options. It has a simple appearance by means of its flat lines, and a different design with an inclined and angled water drainage chamber. It provides wall-joinery connection integrity with an aesthetic appearance on the inner surface with the groined case profile. It offers different appearance possibilities with its flat sash and fluted sash applications. It operates in concordance with the screen, louver and shutter systems. By means of its design which makes the water discharge easier, its water tightness is high.

Properties	Type of Openings
Profile Width (mm) 70	
Number of Chamber for Frame Profile 5	
Glass Thickness (mm) 4 - 40	
Thermal Insulation ( $U_w$ ) W/m <sup>2</sup> K Class 4	
Air Permeability Class C5/B5	

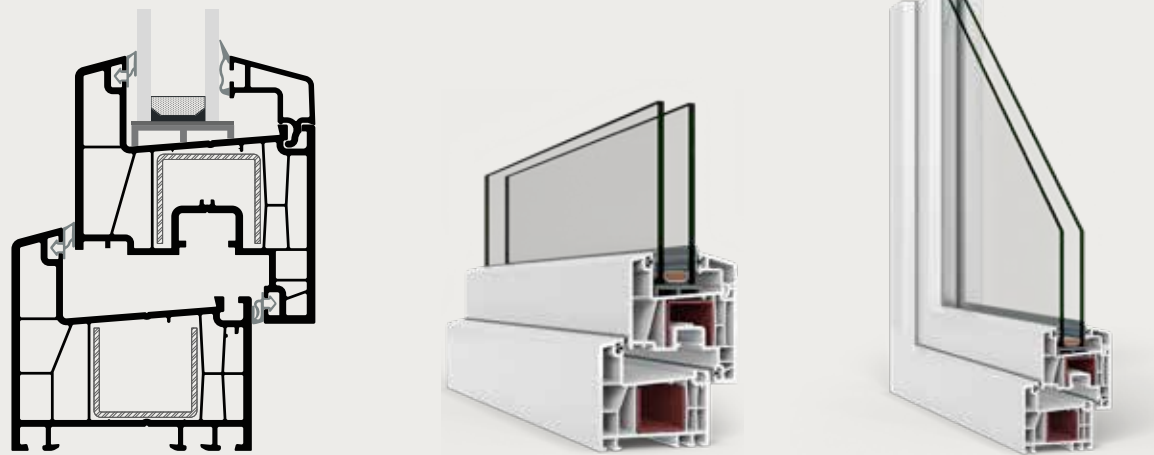
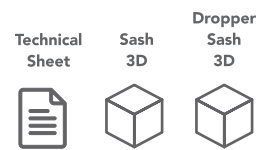

Sustainable Lead Free





## MAXI RIVIERA

It has a double sash adaptor for French type balcony applications.  
There are case profiles of 105,125,145 and 165 mm with sill as well as regular 70 mm.

Properties		Type of Openings
Profile Width (mm)	70-105-125-165	
Number of Chamber for Frame Profile	5 - 6	
Glass Thickness (mm)	4 - 40	
Thermal Insulation ( $U_w$ ) W/m <sup>2</sup> K	1,37	
Air Permeability	Class 4	
Wind Load Resistance	Class C3/B5	

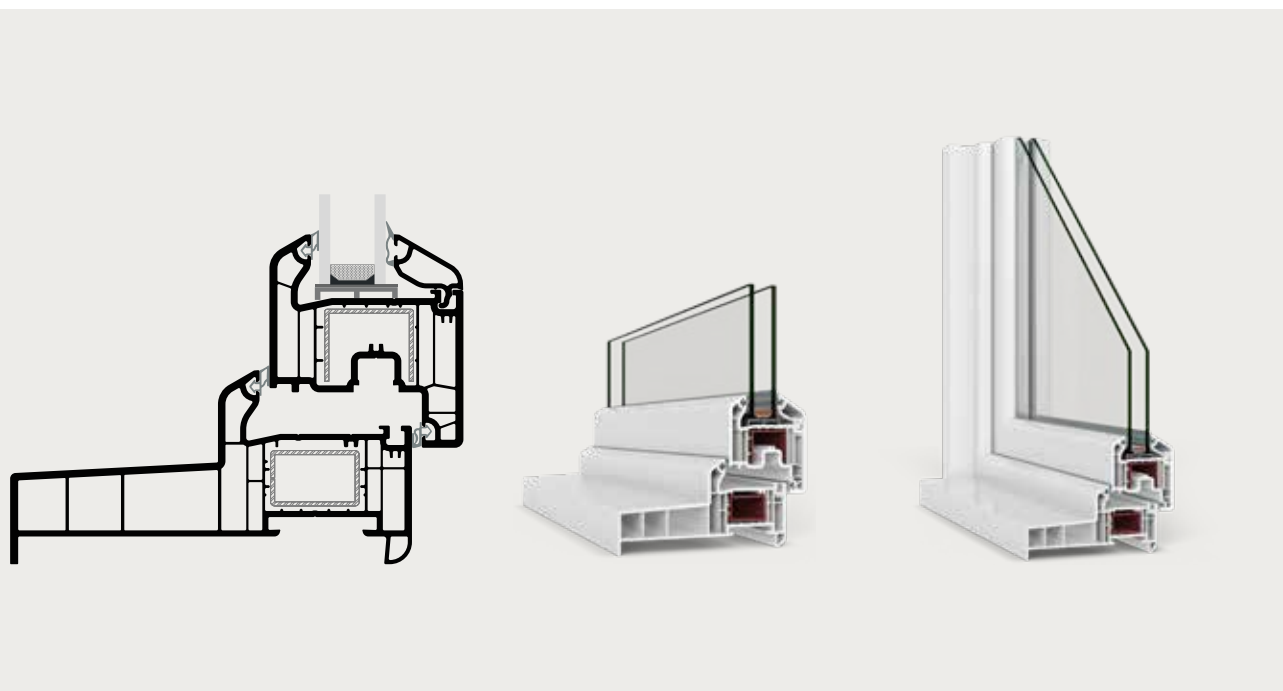
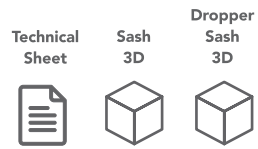

Sustainable Lead Free





## MAXI MAJESTIC

The system has 70 mm profile width. The windows are opening to outside with specially designed case, sash and middle sash bar profiles.

Properties	Type of Openings
Profile Width (mm) 70	
Number of Chamber for Frame Profile 5	
Glass Thickness (mm) 4 - 40	



Technical Sheet 3D

3D Technical Sheet

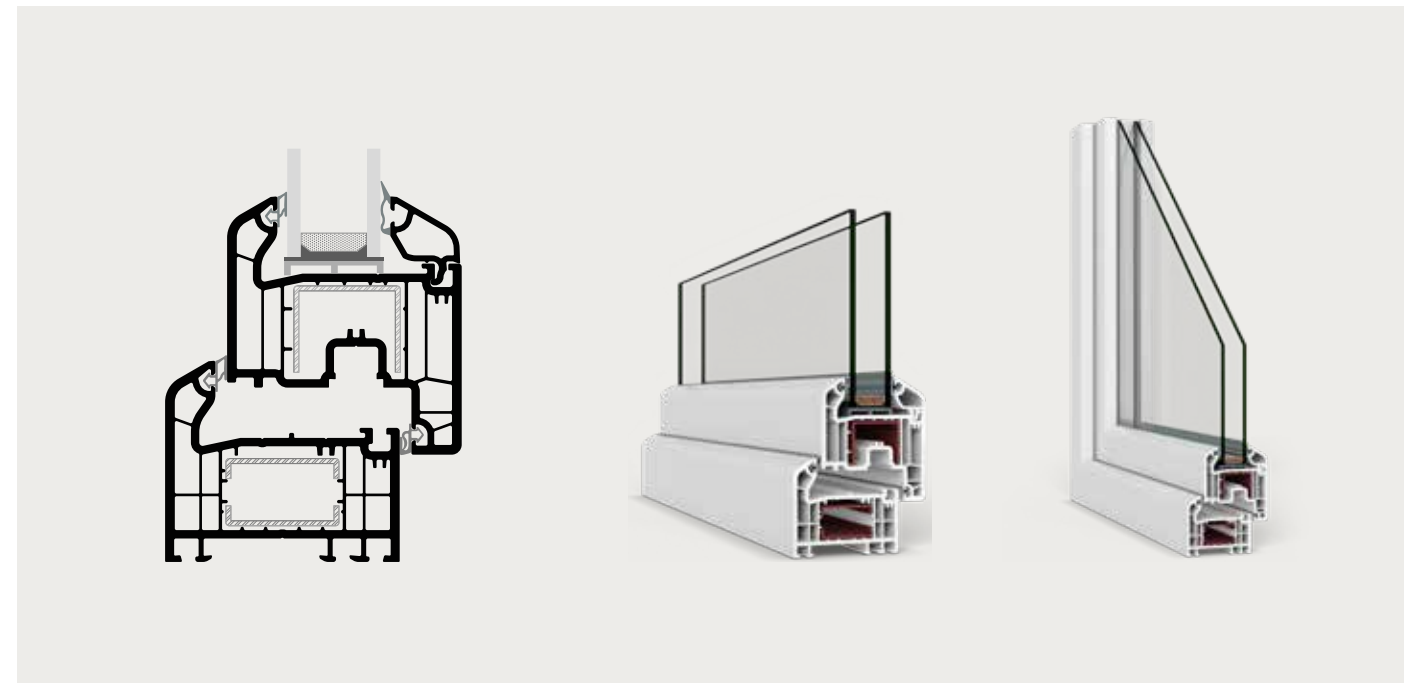
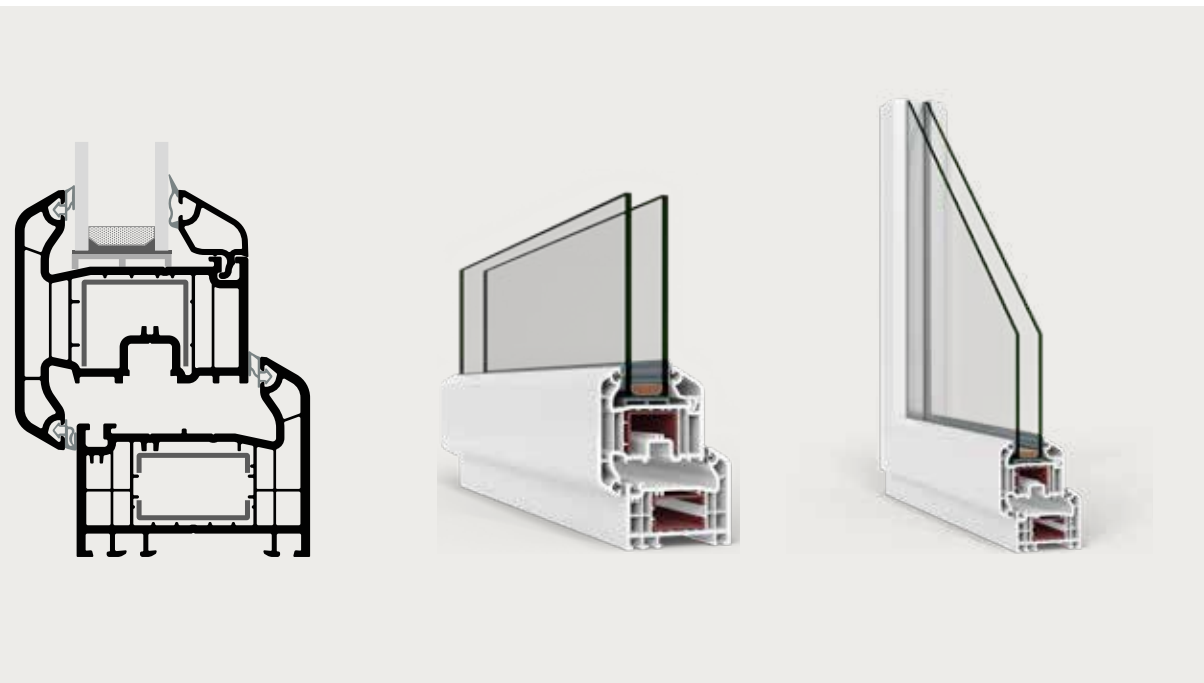

Sustainable Lead Free

Sustainable Lead Free



## MAXI EMPIRE

With its 120 mm wide and 5-chamber profiles; It provides insulation performance above expectations in high-rise buildings. It has a non-retentive inclined outer surface.

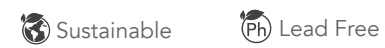
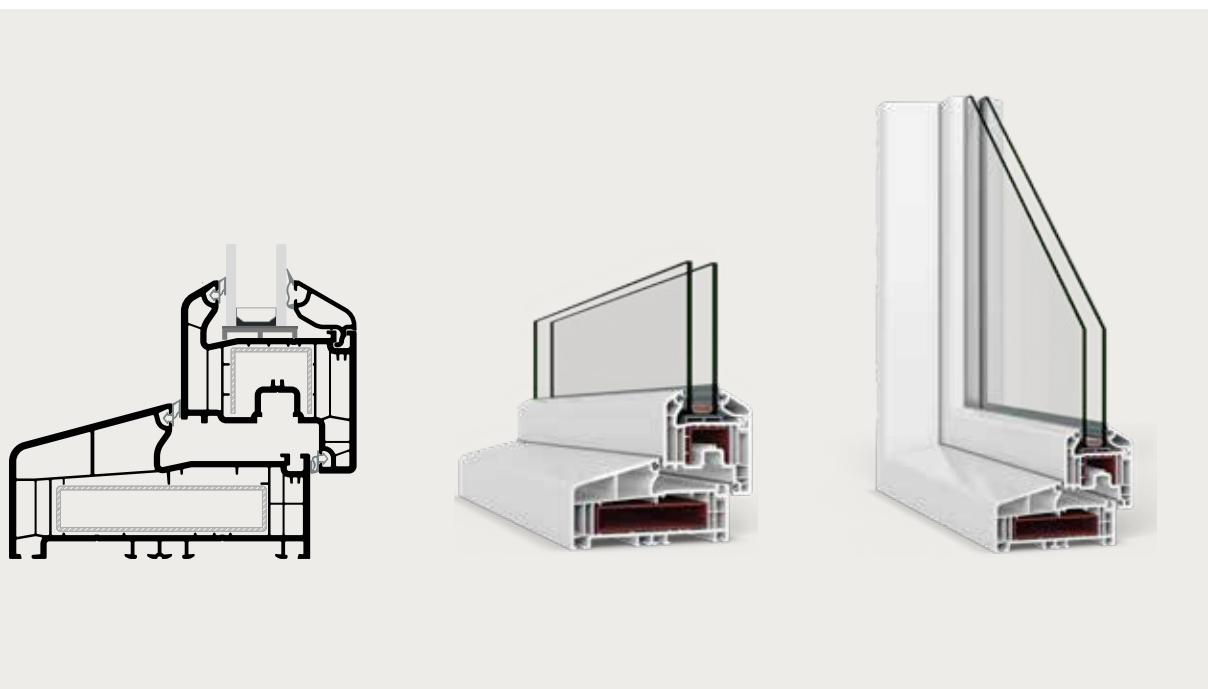
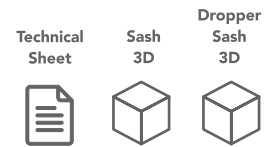

Properties	Type of Openings
Profile Width (mm) 120	
Number of Chamber for Frame Profile 5	
Glass Thickness (mm) 4 - 40	
Thermal Insulation ( $U_w$ ) W/m <sup>2</sup> K 1,45	
Air Permeability Class 5	
Wind Load Resistance Class C5/B5	



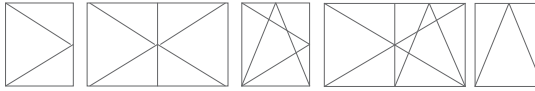

## ELEGANS 60 mm

To ensure maximum sound and heat insulation with its 4-chambered design, it provides usage opportunity for quality glasses between the range of 4, 20, 24, 30 mm and different lath options. It has a simple appearance by means of its flat lines, and a different design with inclined and angled water drainage chamber. It provides wall joinery connection integrity with aesthetic appearance on the inner surface with the groined case profile. It operates in concordance with screen, louver and shutter systems. By means of its design which makes the water discharge easier, its water tightness is high.

Properties	Type of Openings
 Profile Width (mm) 60	
 Number of Chamber for Frame Profile 3,4	
 Glass Thickness (mm) 4 - 31	





Technical Sheet 3D

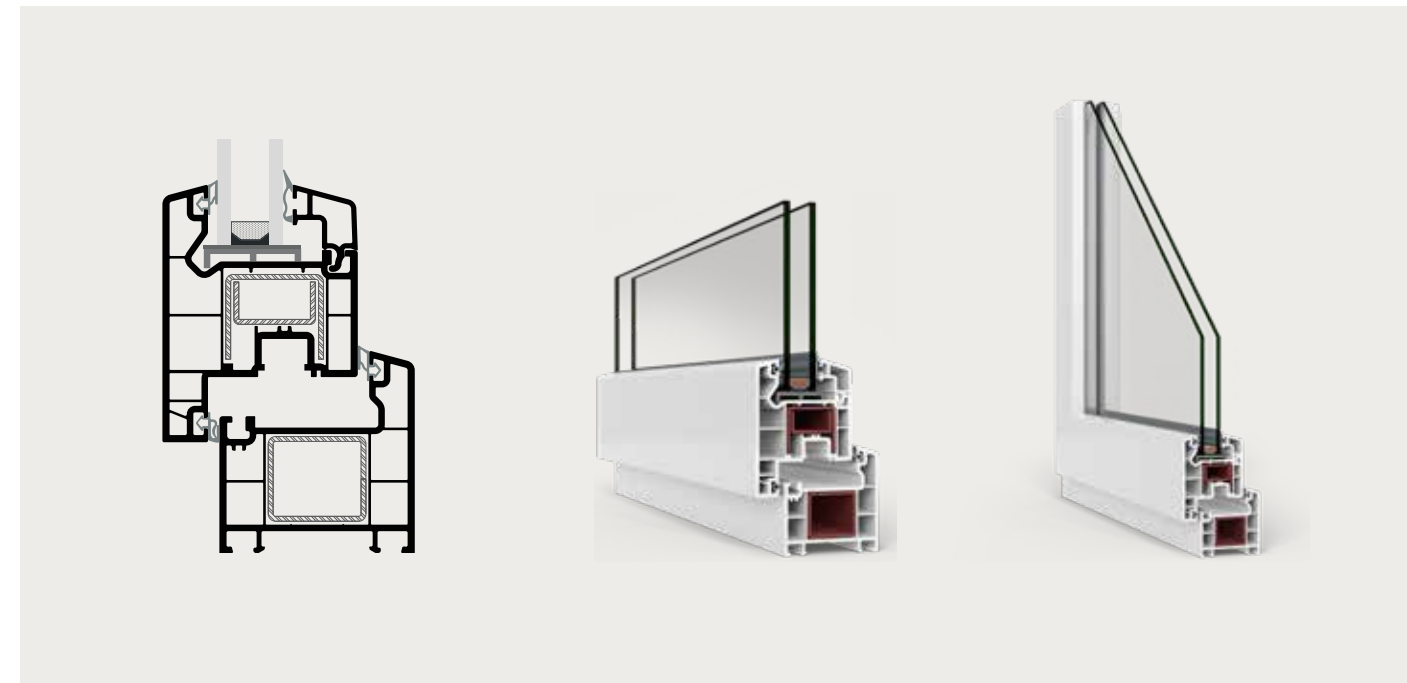

 Sustainable  Lead Free

3D Technical Sheet









 Sustainable  Lead Free



## DIAMOND 60 mm

It offers different appearance possibilities with its flat sash and fluted sash applications. It provides wall joinery connection integrity with an aesthetic appearance on the inner surface with the groined case profile. It operates in concordance with the screen, louver and shutter systems. By means of its design which makes the water discharge easier, its water tightness is high.

Properties		Type of Openings
 Profile Width (mm)	60	
 Number of Chamber for Frame Profile	4	
 Glass Thickness (mm)	4 - 30	
 Air Permeability	Class 4	
 Wind Load Resistance	Class C2/A4	

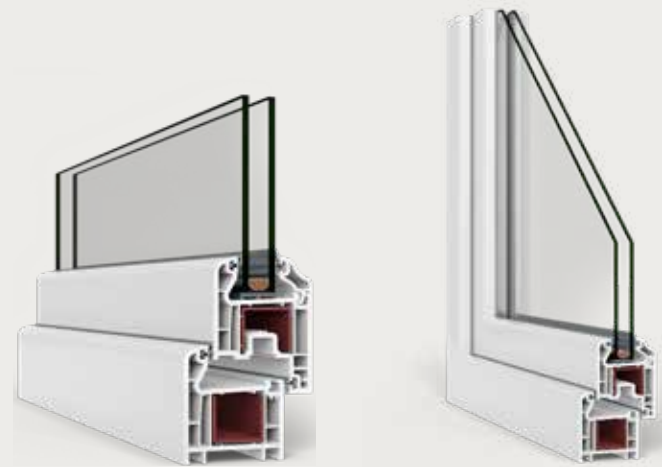
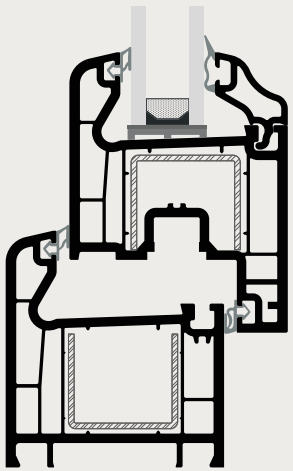
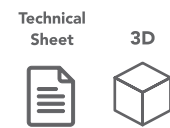



## SLIDING SYSTEM 74 mm

The sashes which are sliding in the direction of their axis instead of opening sashes, allow the spaces to be used more efficiently. By means of its design which makes the water discharge easier, its water tightness is high. The case and middle sash bar have baffled sliding case. Application of fly screen is available for all sliding cases. To ensure maximum sound and heat insulation, it is possible to use with quality glass between the range of 4, 20, 24 and 30 mm.

Properties		Type of Openings							
Profile Width (mm)	74 - 76 - 94,5 - 137	-	-	-	-	-	-	-	x
Glass Thickness (mm)	4 - 30	-	-	-	-	x	-	-	x
Air Permeability	Class 4	-	-	-	-	x	-	-	x
Wind Load Resistance	Class C3/B3	-	-						
		x	x						

Technical Sheet 3D

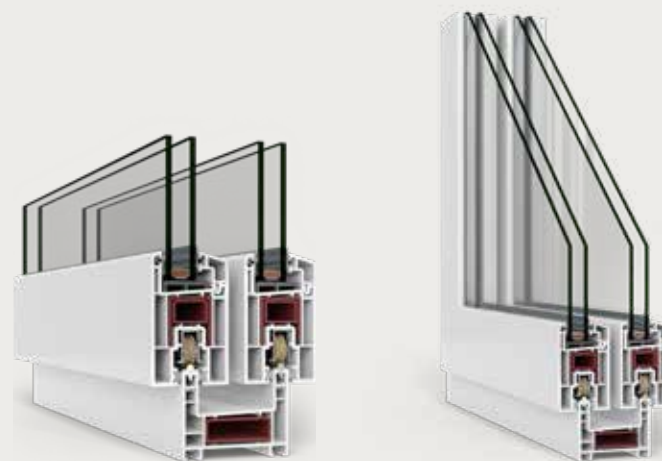
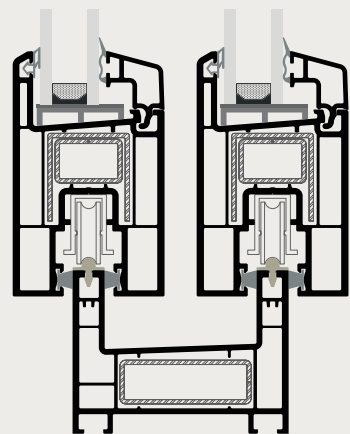

Sustainable



Lead Free









## SLIDING SYSTEM 70 mm

The sashes which are sliding in the direction of their axis instead of opening sashes, allow the spaces to be used more efficiently. By means of its design which makes the water discharge easier, its water tightness is high. The case and middle sash bar have baffled sliding case. Application of fly screen is available for all sliding cases. To ensure maximum sound and heat insulation, it allows the use of quality glasses between the ranges of 4 – 20 mm.

Properties		Type of Openings			
 Profile Width (mm)	70	-	-	-	x
 Glass Thickness (mm)	4 - 20	-	-	-	-

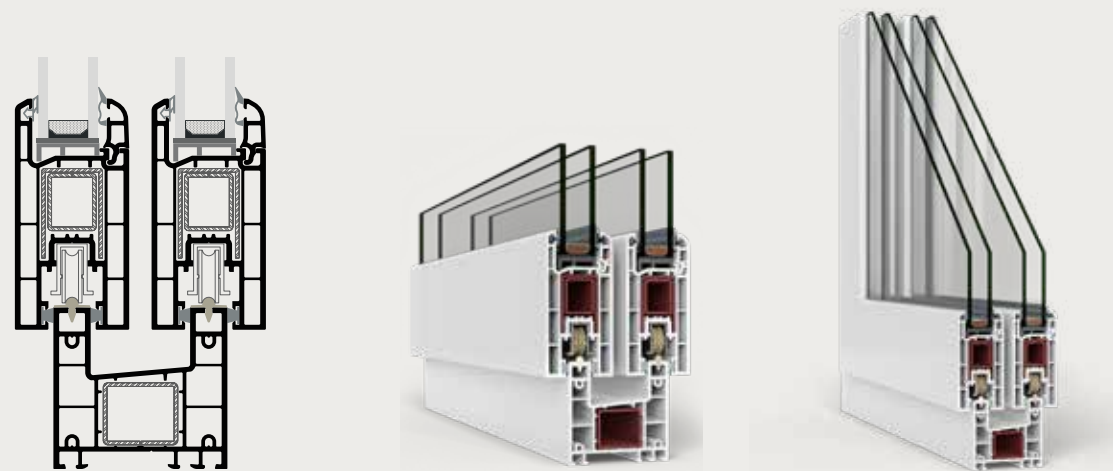
Technical Sheet  3D 



 Sustainable  Lead Free





## COMPACT SLIDING SYSTEM 60 mm

The sashes which are sliding in the direction of their axis instead of opening sashes, allow the spaces to be used more efficiently. Water flow is made unimpeded with the special design. The case and middle sash bar have baffled sliding case. Application of fly screen is available for all sliding cases. By means of the case profile designed optionally, it can be used both as case and as middle sash bar.

Properties		Type of Openings									
Profile Width (mm)	60	<table border="1"><tr><td>-</td><td>-</td><td>-</td><td>x</td></tr></table>	-	-	-	x	<table border="1"><tr><td>x</td><td>-</td><td>-</td><td>x</td></tr></table>	x	-	-	x
-	-	-	x								
x	-	-	x								
Glass Thickness (mm)	4 - 20	<table border="1"><tr><td>-</td><td>-</td><td>-</td><td>-</td></tr></table>	-	-	-	-					
-	-	-	-								
Air Permeability	Class 4										
Wind Load Resistance	Class C2/B3										

Technical Sheet 3D

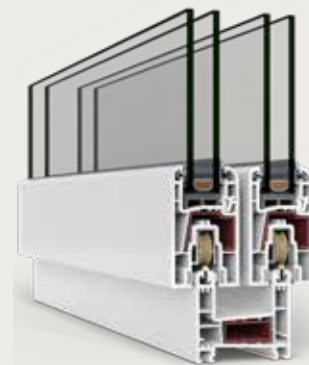
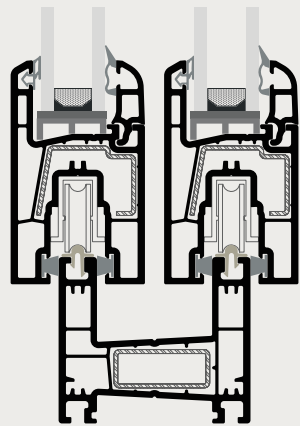

Sustainable Lead Free

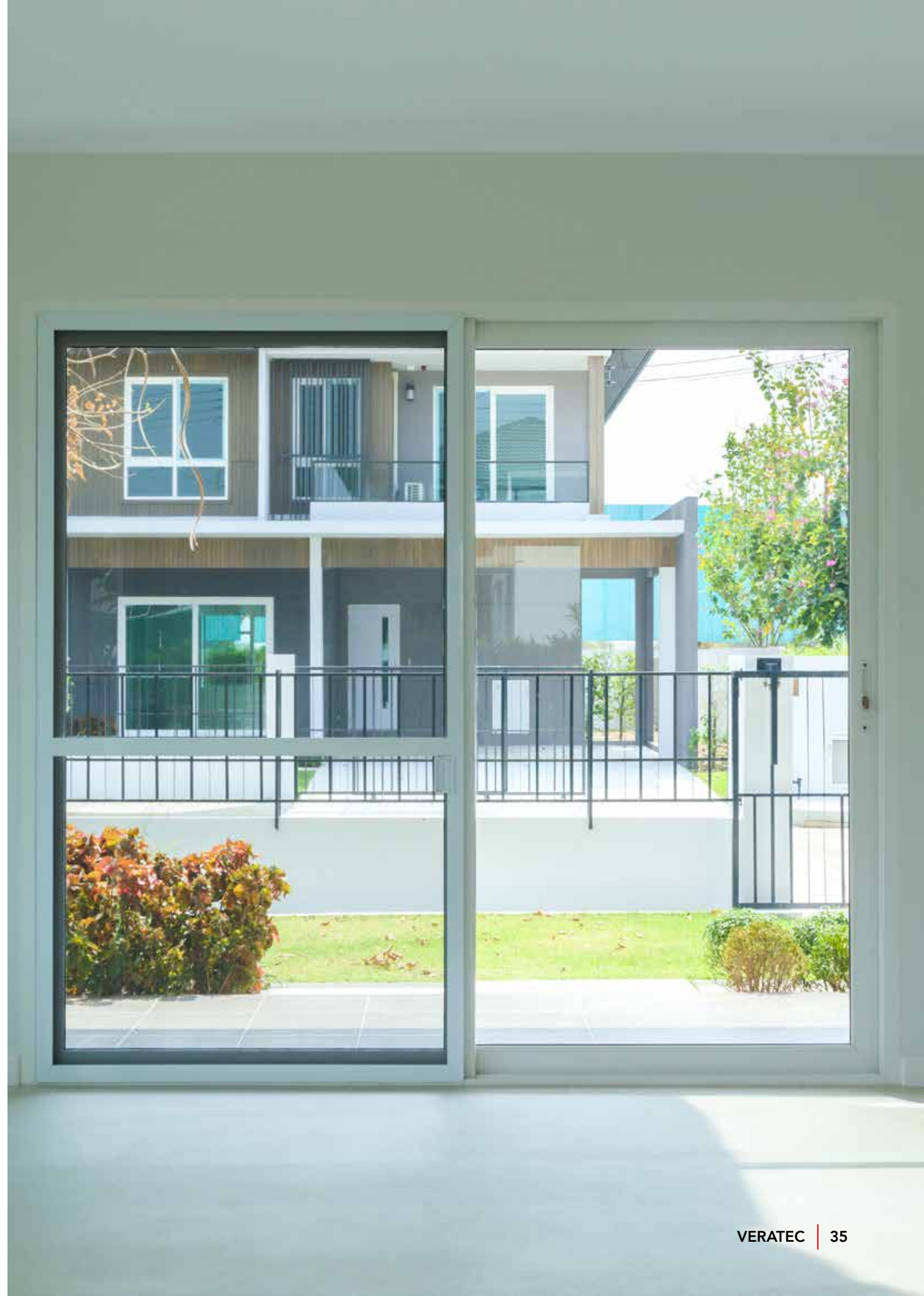



## SILL PROFILES

It can be used as a single part or sectional in

150 - 200 - 250 - 300 - 350 - 400 - 450 - 600 mm, and it is an alternative to marble sill.  
 It is a perfect solution alternative with high resistance against heat insulation and condensation.  
 It provides ease of application on large surfaces and according to the construction forms.  
 They are aesthetic and durable decorative products.

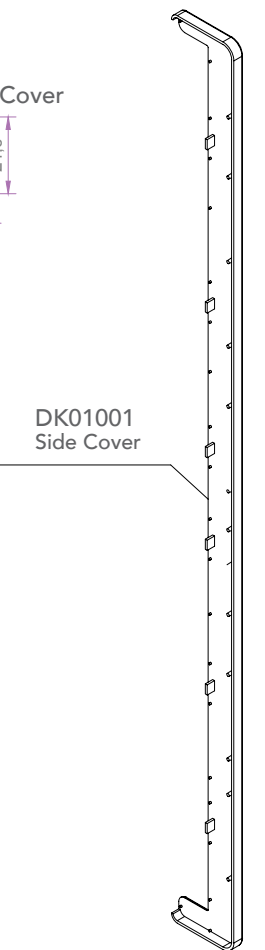
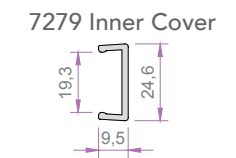
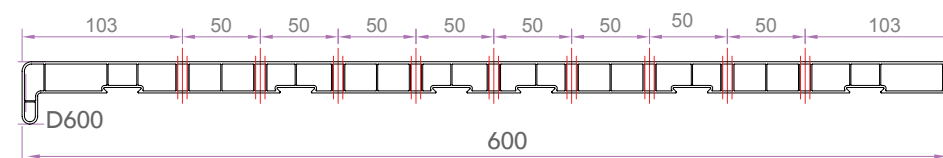
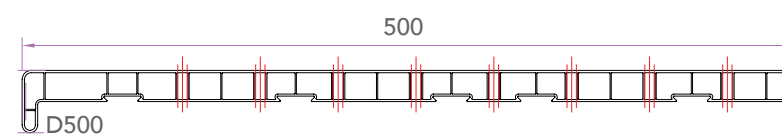
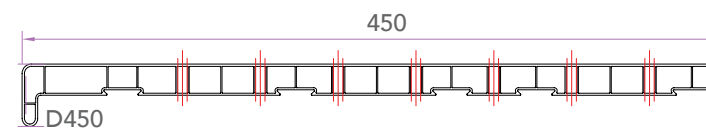
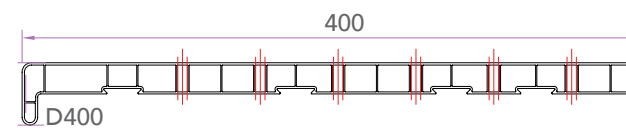
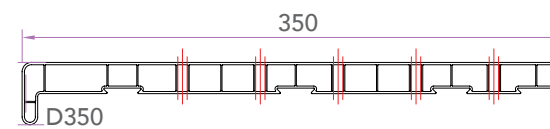
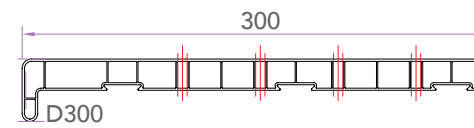
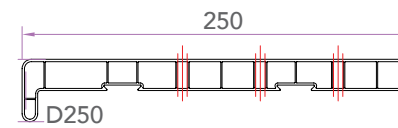
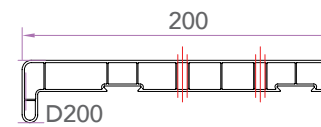
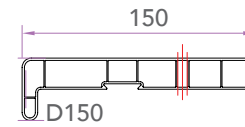
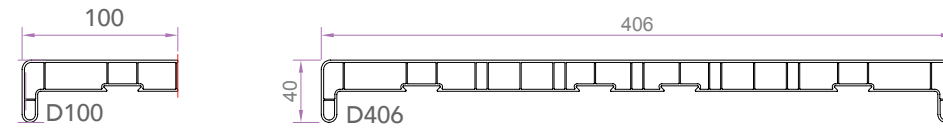
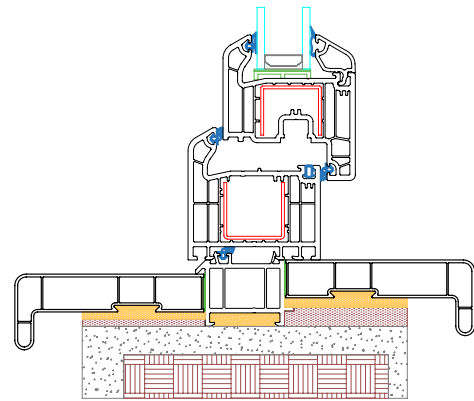



## SILL PROFILES

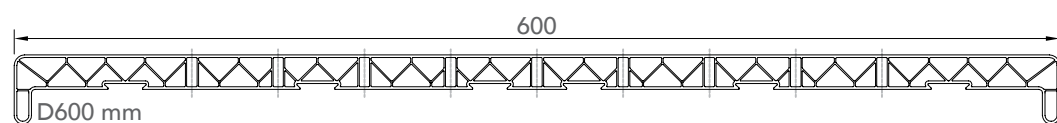
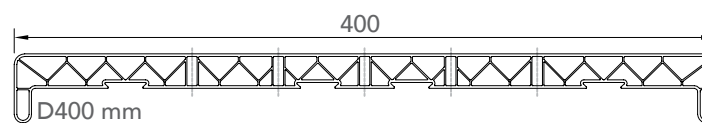
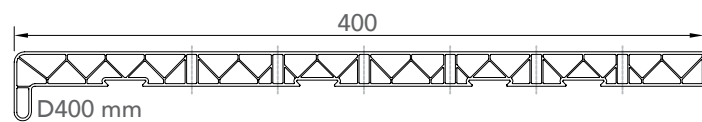
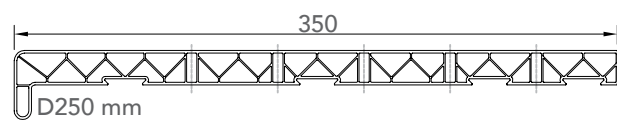
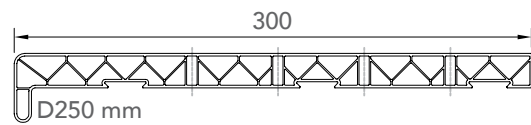
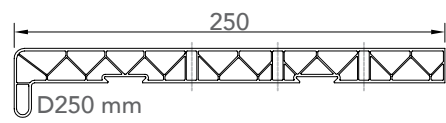
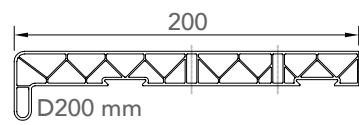
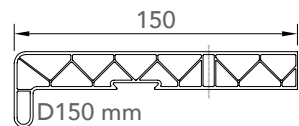
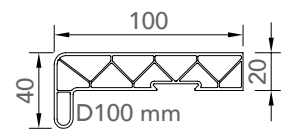
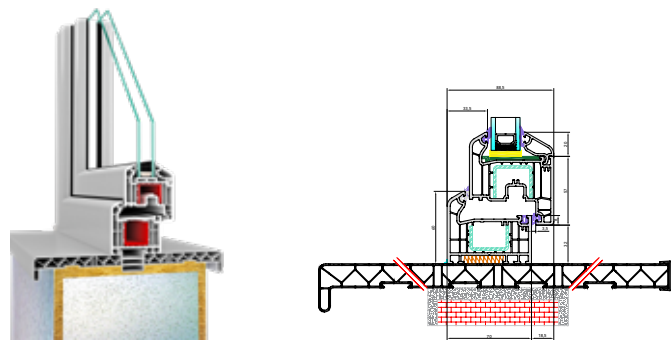

End Cap

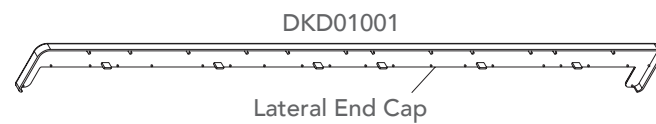

Lateral End Cap

Corner Connection

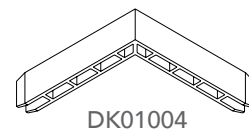

DK01004

Corner Connection

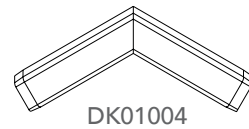

DK01004

## COLOUR OPTIONS

Thanks to its wide product and colour range, ASAŞ is indispensable

<b>PX-20</b> Black Ulti-Matt	<b>MX-92</b> Earl Platin	<b>MX-11</b> Gale Grey Finesse	<b>MX-16</b> Anthracite Grey	<b>MX-64</b> Quartz Grey
<b>MX-21</b> Trompet	<b>MX-15</b> Walnut	<b>MX-24</b> Winchester	<b>PX-98</b> Siena PN	<b>MX-02</b> Dark Oak
<b>MX-91</b> Soft Cheery	<b>MX-04</b> Golden Oak	<b>MX-23</b> Cottony Winchester	<b>MX-14</b> Anteak	<b>FX-14</b> Aluminium Brush Effect
<b>PX-08</b> Ice Cream				





## EXTERNAL ROLLER SHUTTER SYSTEMS

Different sizes of polyurethane injected aluminum slats as 37 mm, 39 mm, 43 mm, 55 mm and 77 mm to ensure the desired visual effect and technical requirements of a single piece of roller shutter.

- Single/double walls for 55 mm, 60 mm, 77 mm and 100 mm aluminium extrusion slats
- Special aluminium extrusion profiles for commercial usage with light transmittance holes and bulletproof strength
- Aluminum boxes with the sizes of 137 mm, 150 mm, 165 mm, 180 mm, 205 mm, 250 mm, 300 mm, 330 mm, 350 mm and 400 mm
- Options for 45 degrees, 90 degrees, semi-circular and full circular in boxes and side covers
- Options for 40 mm, 60 mm and 70 mm octagonal galvanized steel tubes and 102 mm round steel tubes
- Integrated mosquito screen compliance

Assortment of accessories to complement the system

### Box options

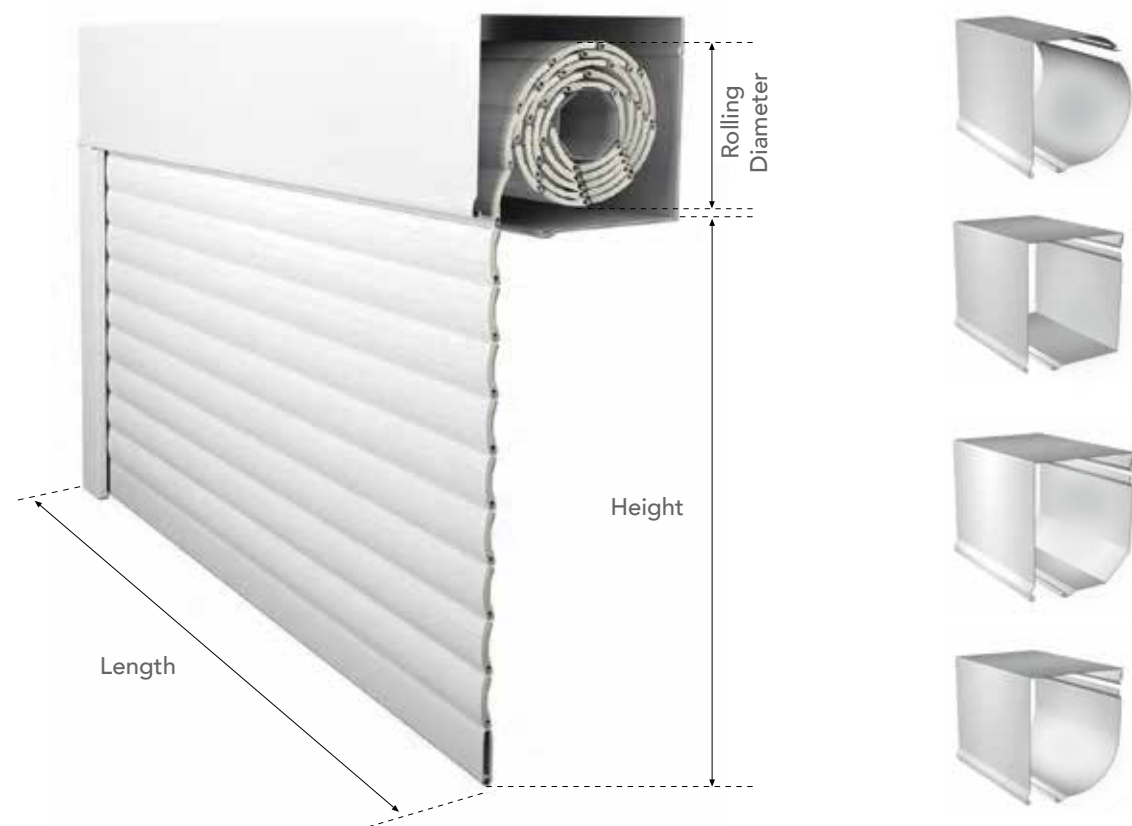



## uPVC AND ALUMINIUM MONOBLOCK ROLLER SHUTTER SYSTEMS

### uPVC and Aluminium Monoblock Roller Shutter Systems

Different sizes of polyurethane injected aluminum slats as 37 mm, 39 mm, 43 mm and 55 mm to ensure the desired visual effect and technical requirements of a single piece of roller-shutter.

- Insulated/Non-insulated square box options
- Specially designed heat barrier system
- Special gaskets that provide insulation by preventing wind passage in box joints
- Box height in a single measure (195 mm)
- Adaptor profile for external mosquito screen systems for both blind and sliding options
- Ability to be opened from the bottom and also from the sides.

Assortment of accessories to complement the system

### Box options

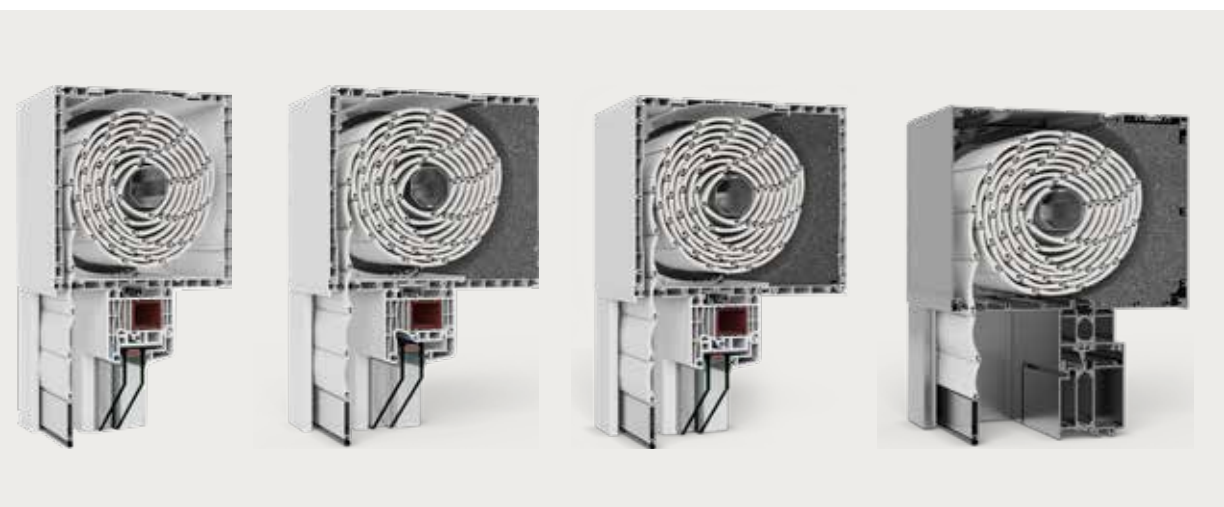
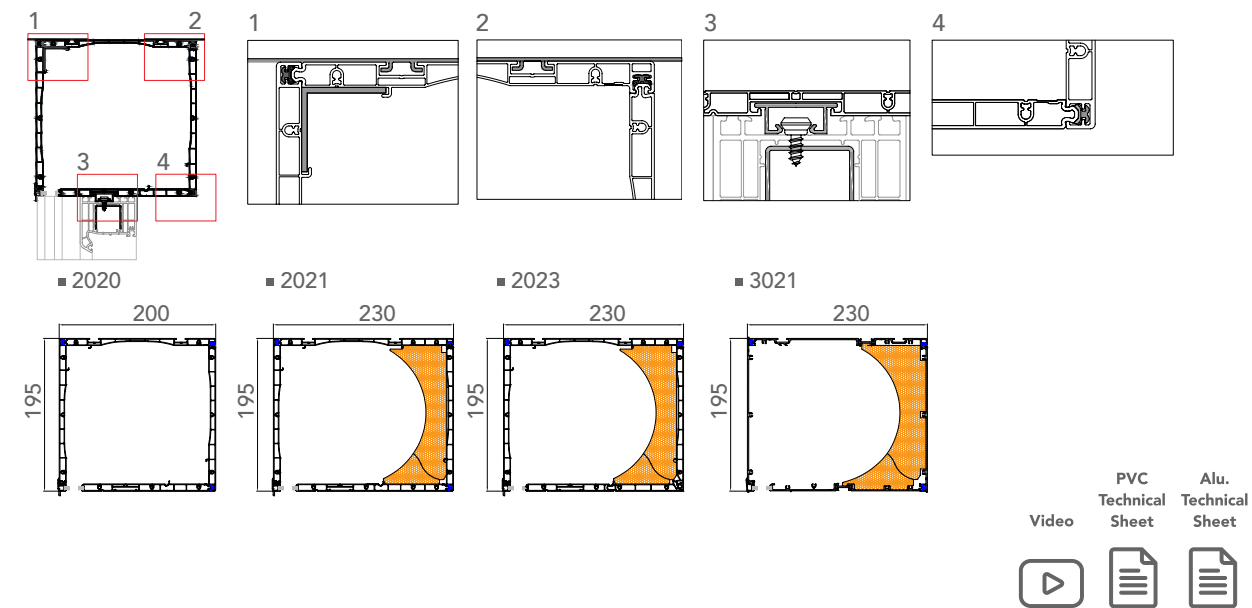



## TUBULAR MOTORS AND CONTROL SYSTEMS

Torque range of 10 NM - 300 NM; Suitable for 40 mm, 60 mm, 70 mm octagonal and 102 mm round pipes, with standard or reducer options, motor types with or without receiver, and shutter systems that can be controlled by remote control.

### Motors



### Manual Systems



### Roller shutter control systems



### Slats



Technical Sheet





## ZEBRA ROLLER SHUTTER

### Roller Shutter Systems

As Bright As You Wish, At The Level You Want  
Easily control the light-shadow level of your home or workplace with specially designed Zebra Roller Shutter System which is a first in the world and Türkiye, enjoy comfort and innovation.

Here are some examples of levels that symbolize the operation of the Zebra Shutter:

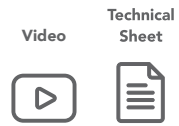
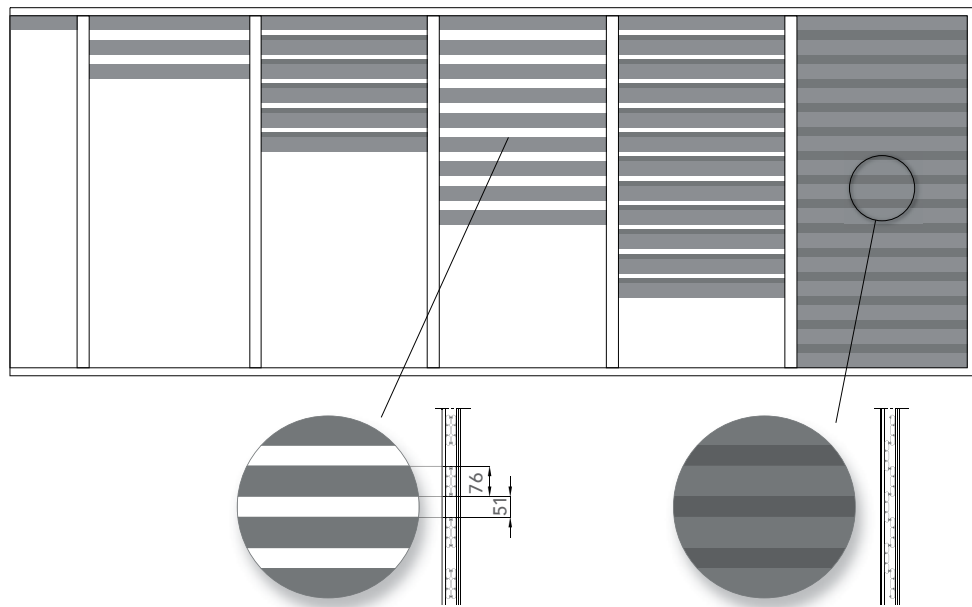

Roller Shutter Height (cm)	Rolling Diameter (mm)
100	228
120	236
140	245
160	255
180	265
200	272
220	280
240	290
260	298
280	308
300	320

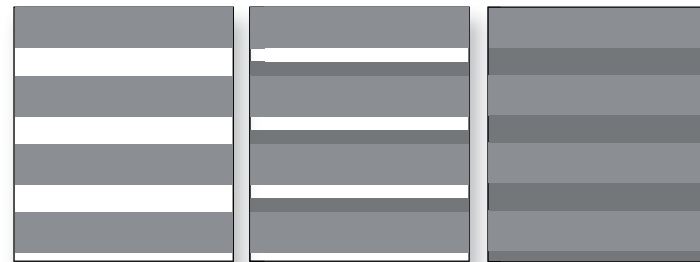

<b>Maximum Recommended Length</b>	160 cm
<b>Maximum Recommended Height</b>	240 cm





## DAYLIGHT Daylight Roller Shutter Systems

Aesthetic, Bright and Comfortable  
With aluminium extruded roller shutters, adjust the light, shade, fresh air as you wish.  
Add aesthetics and value to your buildings...

Here are some examples of levels that symbolize the operation of the Daylight Shutter:



Completely closed    Open as you wish    Either closed and open    Completely open

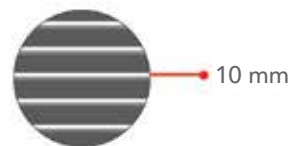

10 mm



20 mm



Technical Sheet

Roller shutter with 10 mm distances	
Roller shutter Height (cm)	Rolling Diameter (mm)
100	18,5
120	19,5
140	20,5
160	21,5
180	22,5
200	23,5
220	24,5
240	25,5
260	26,5
280	27,5
300	28,5
<b>Maximum Recommended Length</b>	200 cm

Roller shutter with 20 mm distances	
Roller shutter Height (cm)	Rolling Diameter (mm)
100	18,5
120	20,0
140	21,0
160	22,5
180	24,0
200	24,5
220	25,5
240	26,5
260	28,0
280	28,5
300	29,0
<b>Maximum Recommended Height</b>	230 cm







### The Quality Policy

The Quality Policy of our company which adopted "Total Quality Management" approach is:

To provide the products:

- at international quality standards,
- with higher quality than expected,
- with high performance capability,
- at reasonable price levels,
- on time and continuously, which may make our

customers competitive in their sectors, to be the best and leading firm in the sector with regard to our all areas of activities, to prepare the appropriate backgrounds and environments for putting into effect and ensuring the continuity of specified policies.



### Websites



asaspen.com.tr



asastr.com

### Social Media



Instagram



Facebook



Youtube



Linkedin



X

### 3D Images



Sketchfab



## ASAŞ Alüminyum Sanayi ve Ticaret A.Ş.

Genel Müdürlük / Headquarters  
Rüzgarlı Bahçe Mah., Kumlu Sok., No: 2  
Asaş İş Merkezi, 34810 Kavacık  
Beykoz - İstanbul, Türkiye

**T** +90 216 680 07 80 **F** +90 216 680 07 81

[asastr.com](http://asastr.com)  
[asaspn.com.tr](http://asaspn.com.tr)  
[contact@veratec.com.tr](mailto:contact@veratec.com.tr)

## ASAS GmbH

Rasselsteiner Str. 101  
56564 Neuwied, Deutschland  
**T** +49 (0) 2631 90209-20  
**F** +49 (0) 2631 90209-11